

HAH15C0125P2T2B42

RÜCKENLOCHLENKROLLE Ø 125 MM SERIE P2T2 KUGELLAGER

ROLLE

Raddurchmesser in mm	125
Radbreite in mm	32
Nabenbreite in mm	36
Achsschraube	M8
Lauffläche	Thermopl. Elastomer 95° Shore A grau
Radkörper	Polypropylen grau
Radlager	Kugellager
Fadenschutz	vollflächiger Kunststoff-Fadenschutz
Temperaturbereich	-20°C bis +60°C



GEHÄUSE

Materialstärke Befestigung in mm	2.50
Materialstärke Gabel in mm	2.50
Montageart	Rückenloch
Befestigung in mm	11
Ausladung in mm	40
Gesamthöhe in mm	160
Störkreis in mm	0
dyn. Traglast in kg	100
Testnorm	DIN EN 12530

**CASCOO Europe GmbH**Lütke Haar 15 • 59602 Rüthen
+49 2952 - 970629-0
info@cascoo.eu • www.cascoo.eu

HAH15C0125P2T2B42

RÜCKENLOCHLENKROLLE Ø 125 MM SERIE P2T2 KUGELLAGER

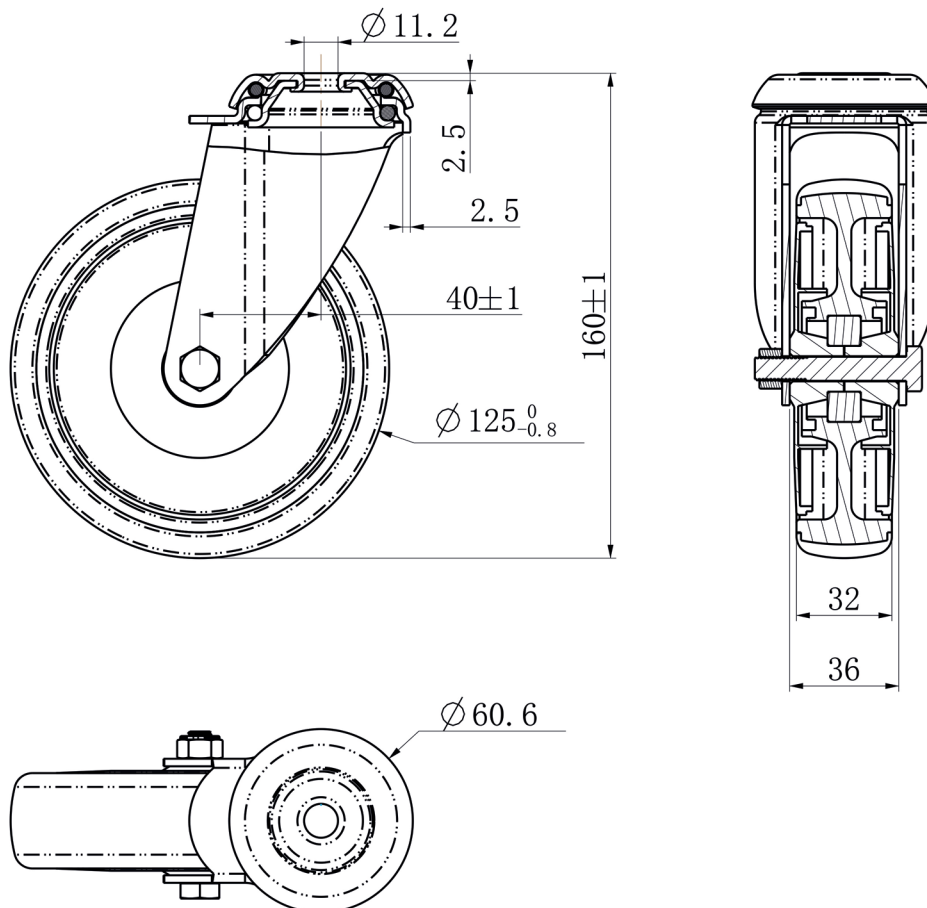

CASCOO Europe GmbH

Lütke Haar 15 • 59602 Rüthen
+49 2952 - 970629-0
info@cascoo.eu • www.cascoo.eu